

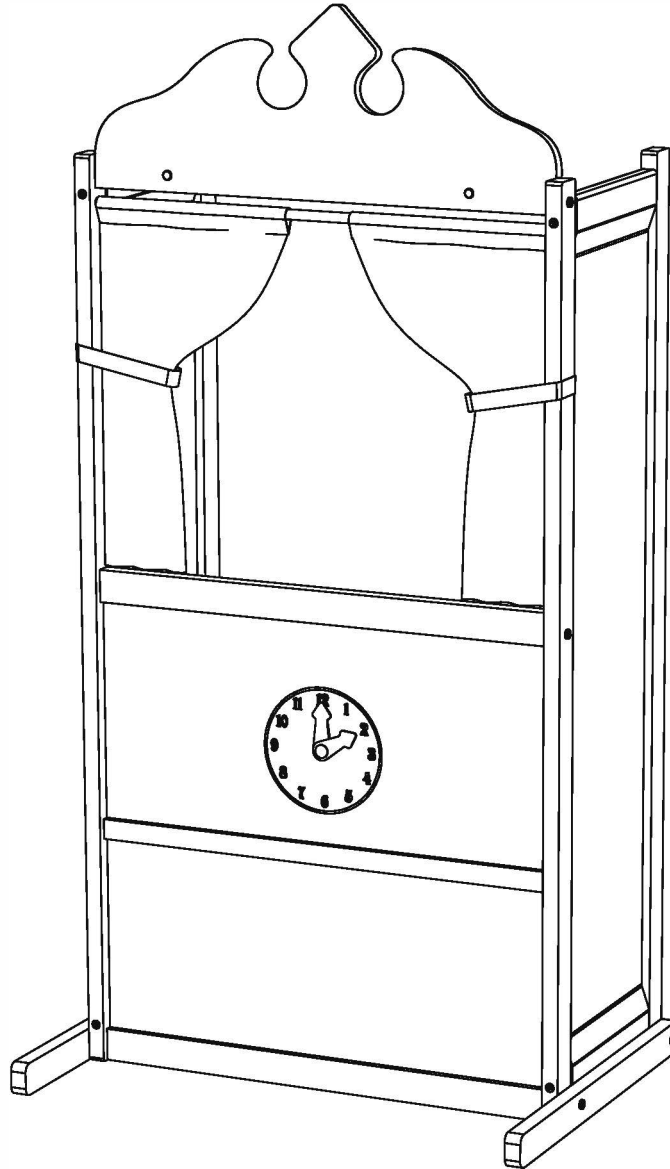

# Deluxe Puppet Theater

## ASSEMBLY INSTRUCTIONS



Have a question or need help? Give us a call! 1-800-284-3948

Item # 2530

Ages 3+

We care about your comments. Please call us!

*Melissa & Doug*

1-800-284-3948

www.MelissaAndDoug.com

Melissa & Doug products meet or exceed U.S. testing standards and pass our high quality requirements.

© Melissa & Doug, LLC, P.O. Box 590, Westport, CT 06881

MADE IN CHINA

**WARNING:**  
CHOKING HAZARD - Small Parts.  
Not for children under 3 years.

**WARNING:**  
KEEP AWAY FROM FIRE.  
**CAUTION:**  
ADULT ASSEMBLY REQUIRED.

# THANK YOU!

Thank you for choosing the Melissa & Doug Deluxe Puppet Theater! It's a terrific way to help nurture a child's creativity and imagination, and to inspire hands-on independent play and storytelling for years to come.

---

## NOW IT'S TIME TO PUT IT TOGETHER!

Don't worry, assembling your new puppet theater is simple, and we're here to help. It may go a little faster with a partner to lend a hand, but we've made it so one person can assemble the theater. Here are a few tips before you begin:

- Read through all the instructions first.
- Clear a flat, covered space (carpeted is best) to lay out all the materials so everything is close at hand.
- You will need a Phillips head and a flat head screwdriver (not included) to assemble the theater. We've included everything else you need. All parts are labeled with a sticker (A-V).
- The instructions include lots of helpful pictures—we show you, step-by-step, how to align pieces and parts for speedy and accurate assembly. Note that the hardware needed for each step is shown in the upper right corner of the page, each piece being added in a given step is highlighted in gray, and the “assembled view” (what it looks like in the completed product when the step is completed) is included in the lower right corner of every page.
- In the instructions, the name of a part is followed by a letter in parentheses. This letter corresponds to the sticker on the part, as well as the picture of the part shown on pages 2-3.
- Helpful hints are highlighted with a large exclamation point.



**IMPORTANT:** Helpful hints are found here.

- If you have any questions, we're here for you! Give our customer service team a call at 1-800-284-3948!
- 

## WARNINGS!

Retain these instructions for future reference.

**Warning—Prevent Tip Overs!**

- Do not allow children to pull, climb, sit, or stand on any part of the theater.
  - The theater must be placed on a hard, flat, and level surface.
  - For more information on how to prevent furniture tip overs in your home, visit [AnchorIt.gov](http://AnchorIt.gov).
  - The theater must be assembled as instructed.
- 

## MAINTENANCE:

Ensure the puppet theater continues to function properly and safely by regularly checking the hardware and tightening when necessary.

# PARTS - Be Smart—Sort Your Parts

Before you begin assembly, make sure you have all the parts listed below. Use the Allen wrench (part V) to attach the bolts, a Phillips head screwdriver (not included) to align the barrel nuts, and a flat head screwdriver (not included) for the binder bolts.

**A** right panel

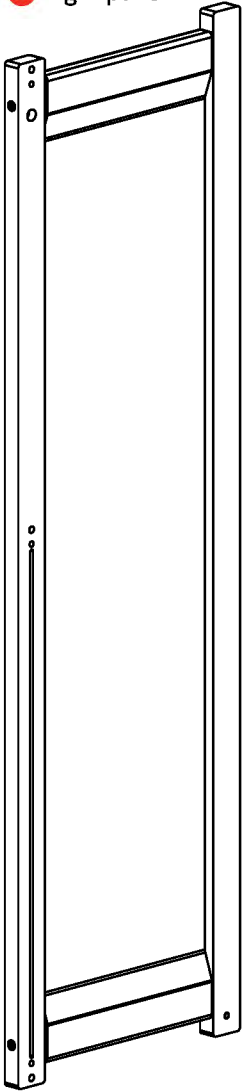

**B** left panel

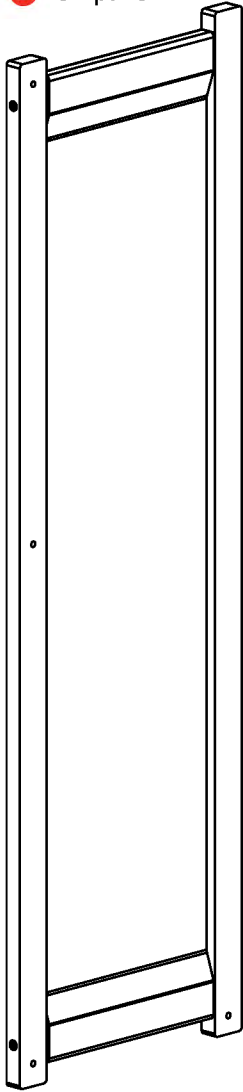

**E** divider

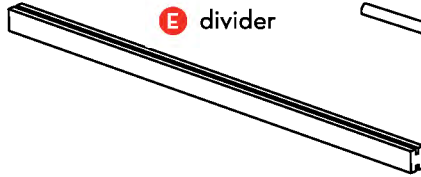

**F** curtain rod

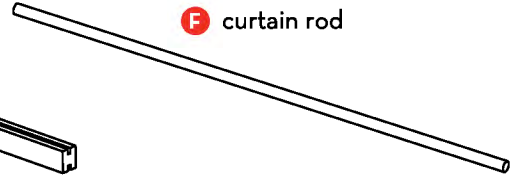

**G** curtains (2)

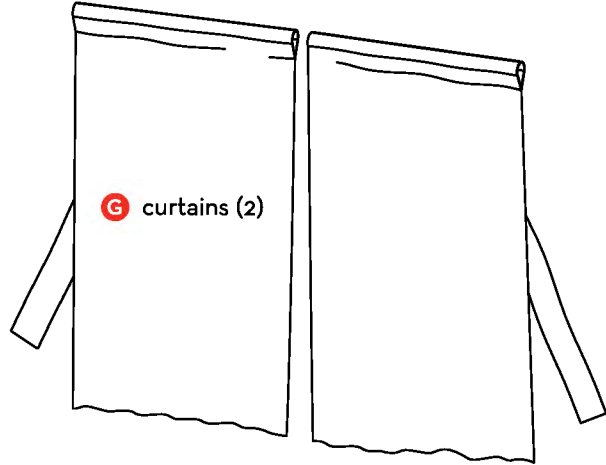

**H** feet (2)

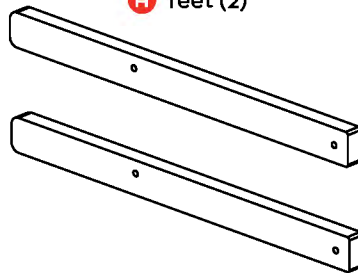

**I** header panel

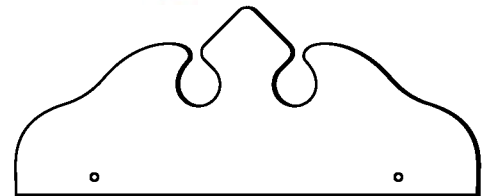

**C** slotted stretchers (2)

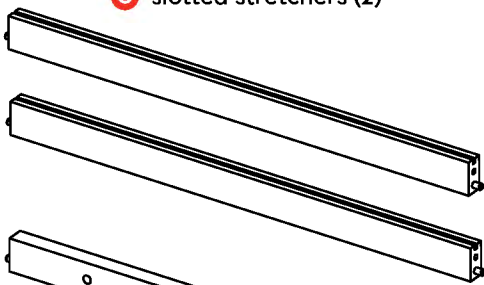

**D** top stretcher (no slot)

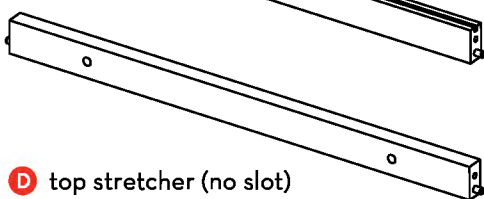

**J** clock panel

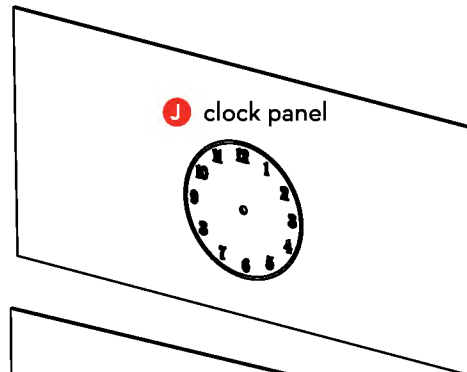

**K** chalkboard

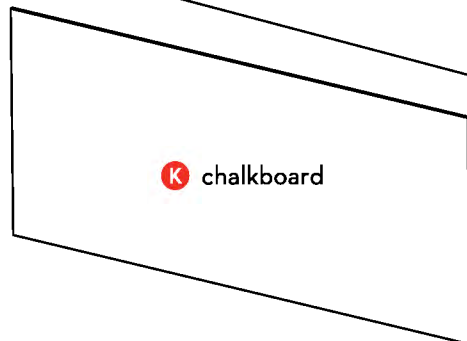

# PARTS (continued)

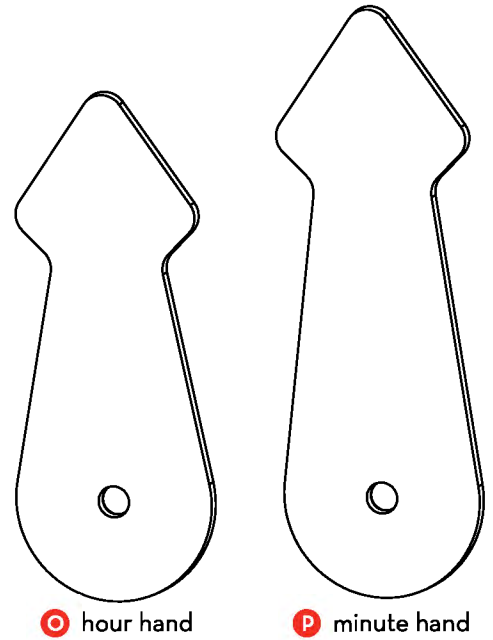
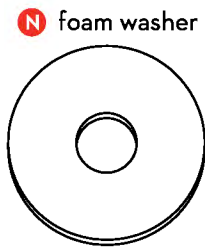
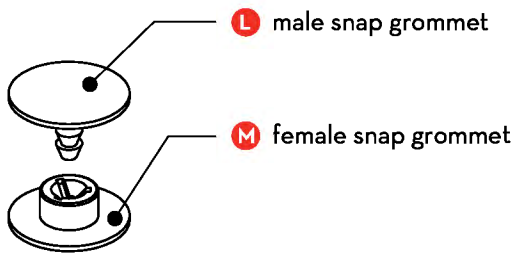

# HARDWARE

**!**  
**IMPORTANT: Some packages of hardware may have extra pieces.**

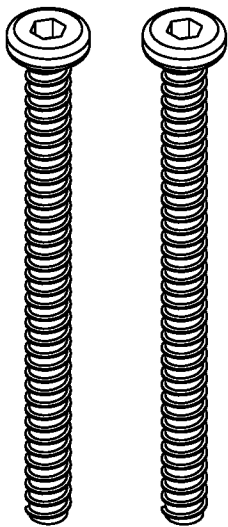

**Q** long bolts (2)

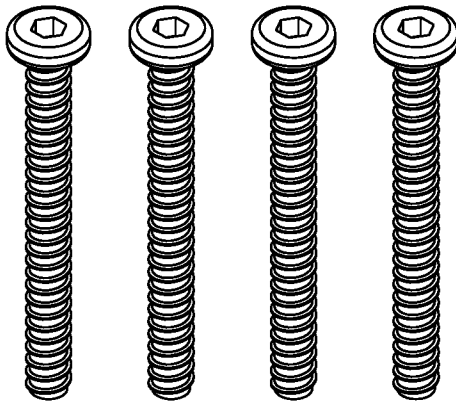

**R** medium bolts (4)

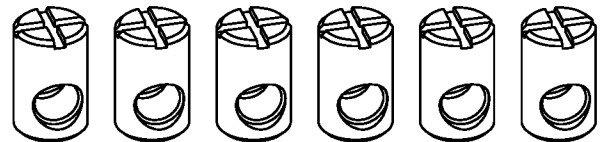

**S** barrel nuts (6)

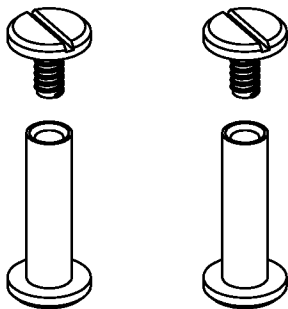

**T** binder nut/bolt sets (2)

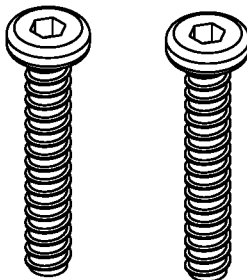

**U** short bolts (2)



**V** Allen wrench

# How to Correctly Install Barrel Nuts

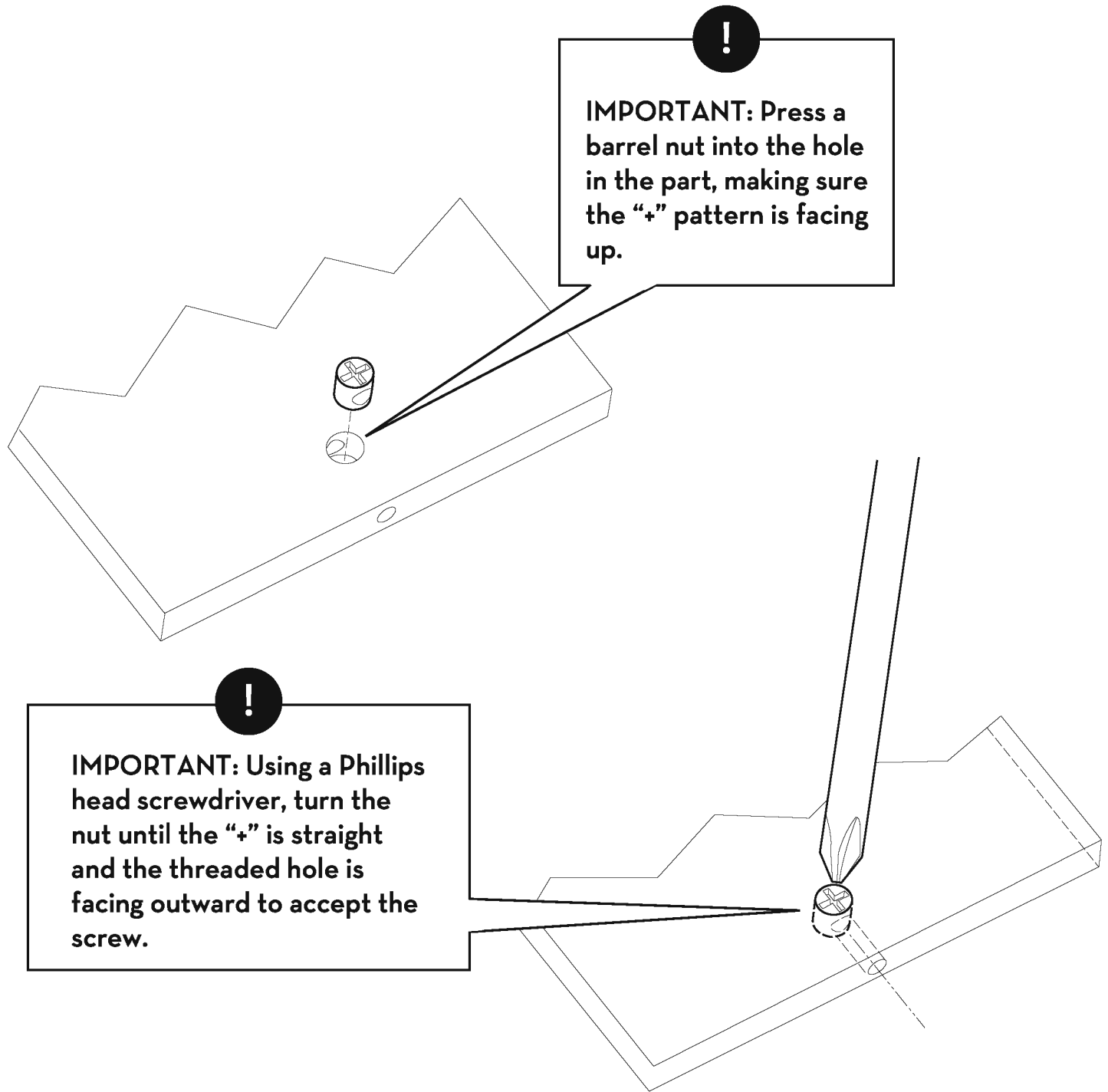

# STEP 1 - Every Journey Begins with the First Step

Assemble clock by fitting male snap grommet (part L) through hour hand (part P), minute hand (part O), clock panel (part J), foam washer (part N), and snapping into female snap grommet (part M).

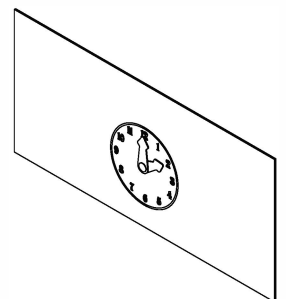
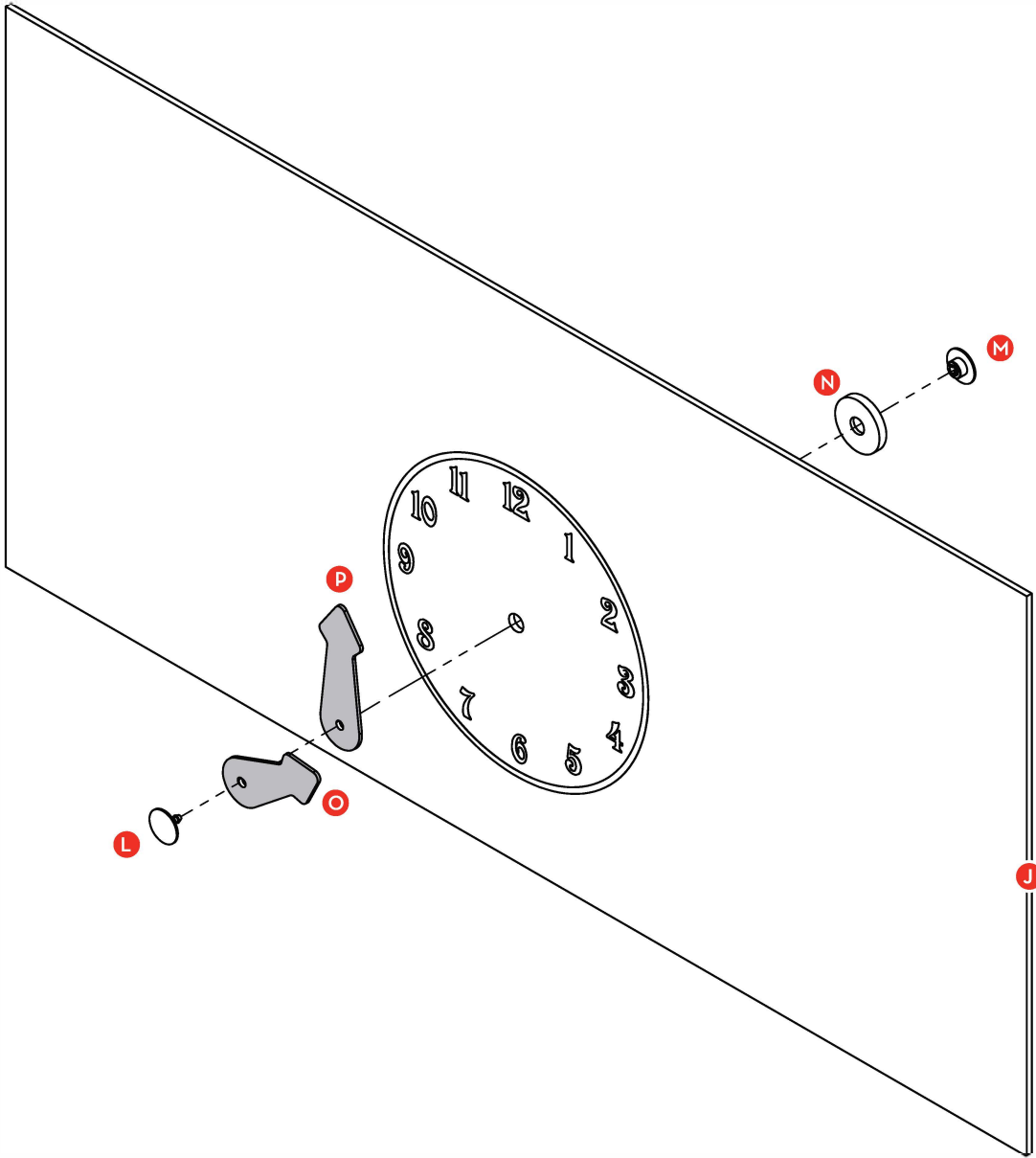
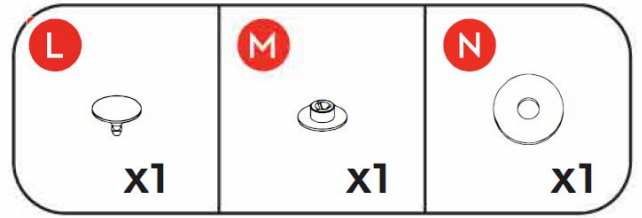

Assembled View

# STEP 2 - Side by Side

Line up hole on the end of one foot (part H) with the threaded insert on the outside of the right panel (part A). Using a short bolt (part U) attach the foot to the panel. Do not tighten—leave slightly loose. Attach the other foot (part H) to the outside of the left panel (part B) in the same way.

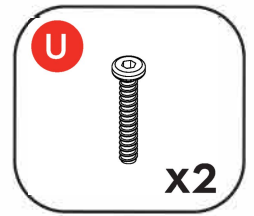

**IMPORTANT:** The inside of the panel has a slot, the outside does not have a slot.

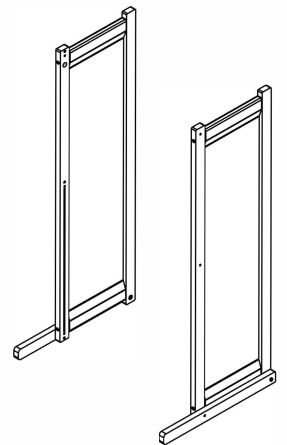
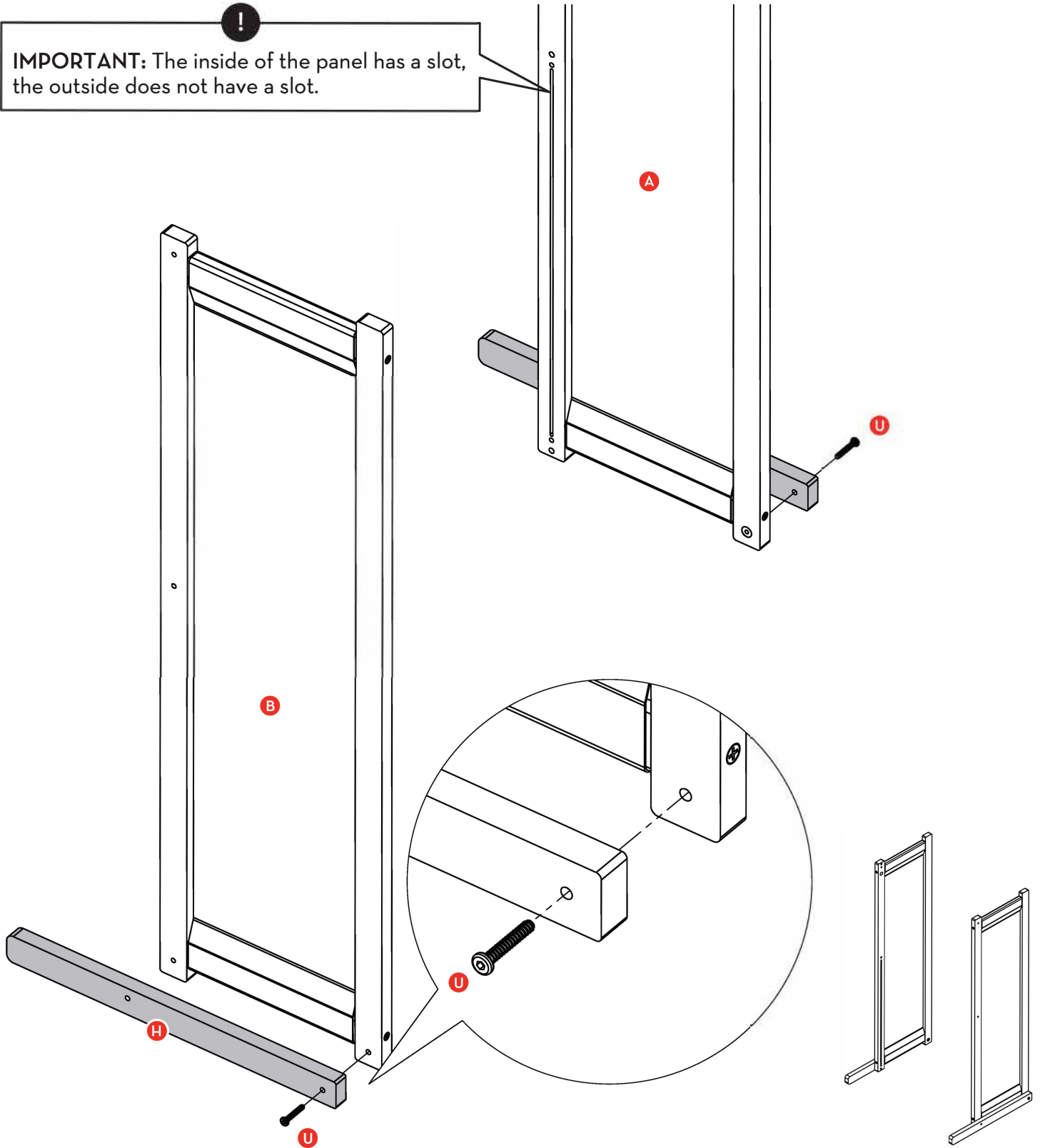

# STEP 3 - We're Here to Support You

Insert two barrel nuts (part S) into a slotted stretcher (part C). Using two long bolts (part Q), attach one side of the slotted stretcher to the base of the left panel assembly, and the other side to the right panel assembly. Leave bolts loose—do not tighten all the way.

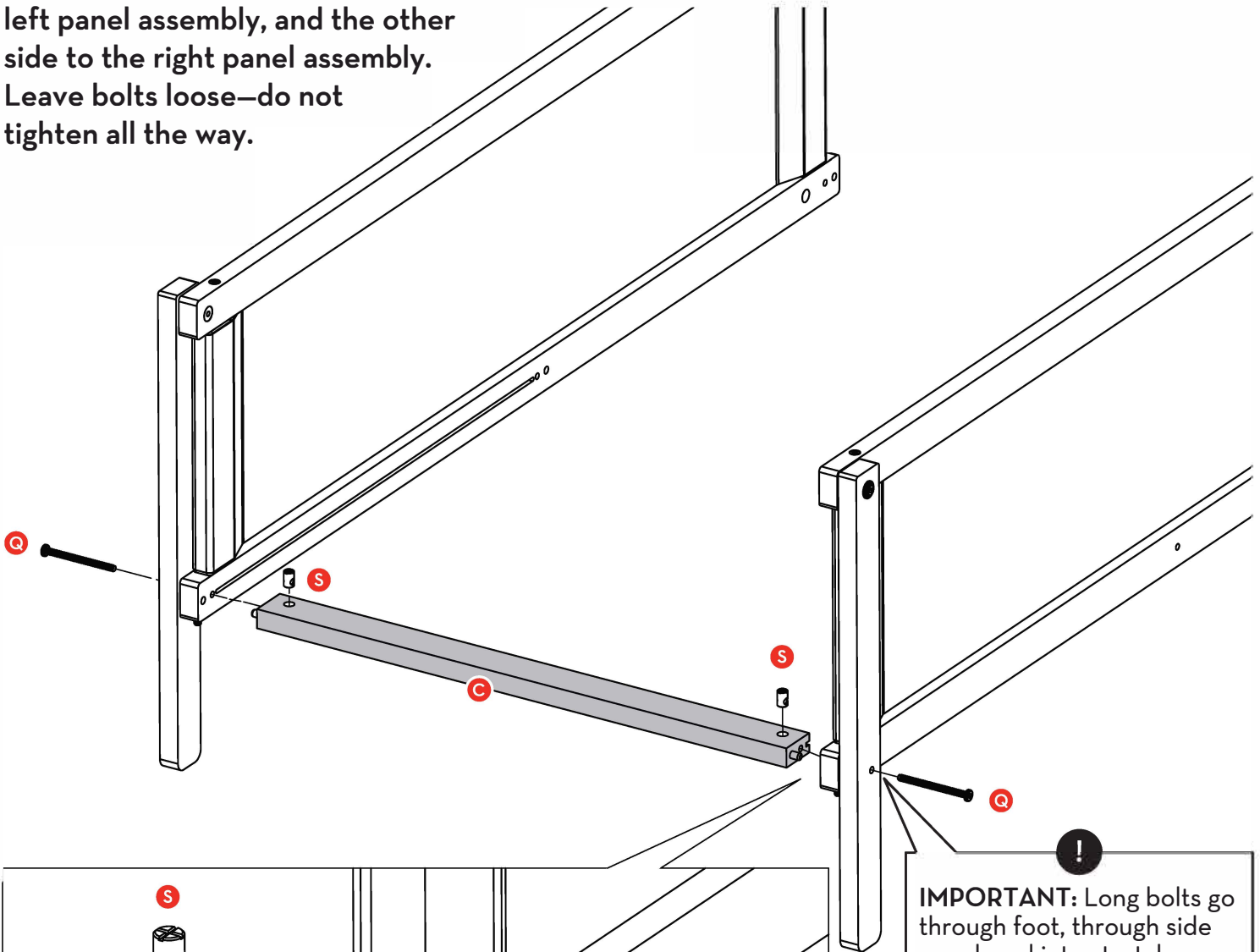
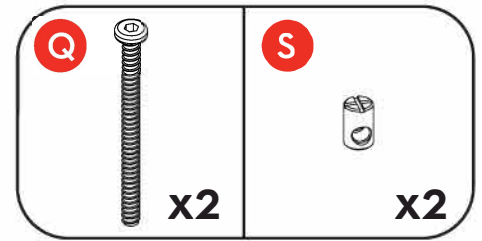

**!**  
**IMPORTANT:** Long bolts go through foot, through side panel, and into stretcher.

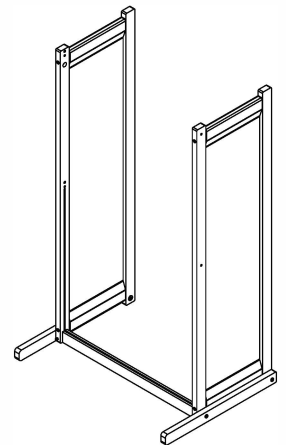
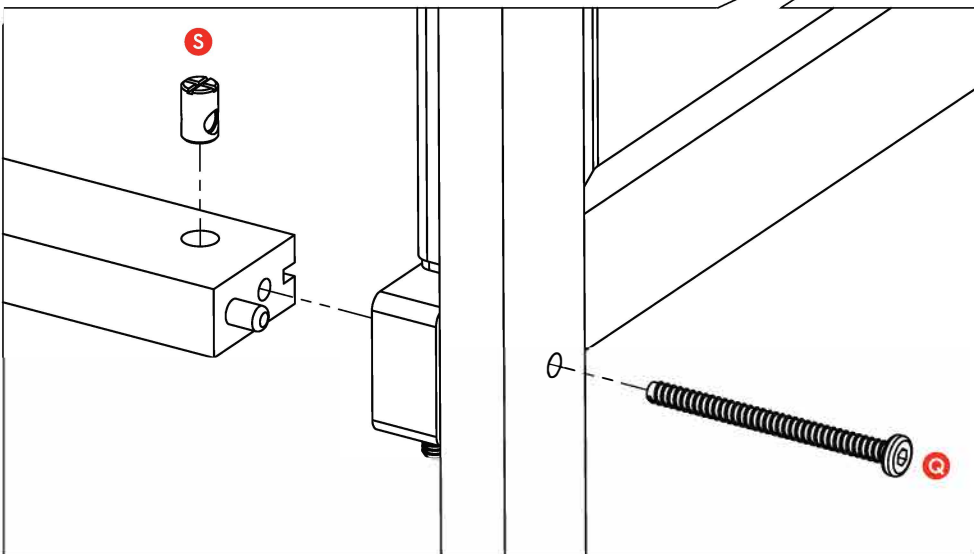

Assembled View



## STEP 4 - Divide and Conquer

Fit the chalkboard (part K) into the slotted stretcher (part C) at the bottom. Fit the divider (part E) on top of the chalkboard. Fit the clock panel (part J) into the divider and place the remaining slotted stretcher (part C) on top.

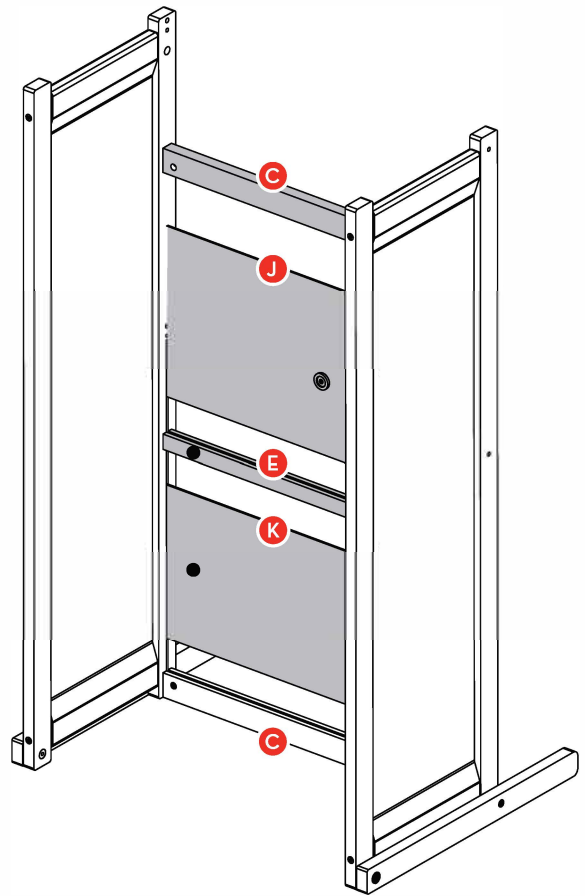

## STEP 5 - Top It Off

Using two medium bolts (part R) and two barrel nuts (part S), attach slotted stretcher (part C) to side panels. Do not tighten bolts all the way.

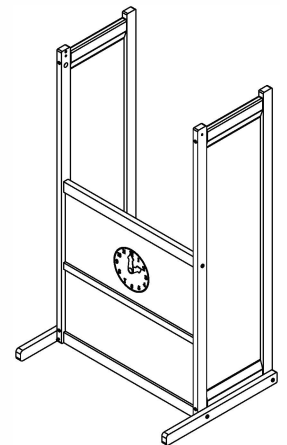
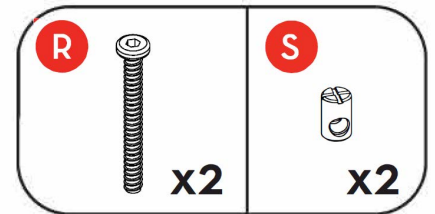
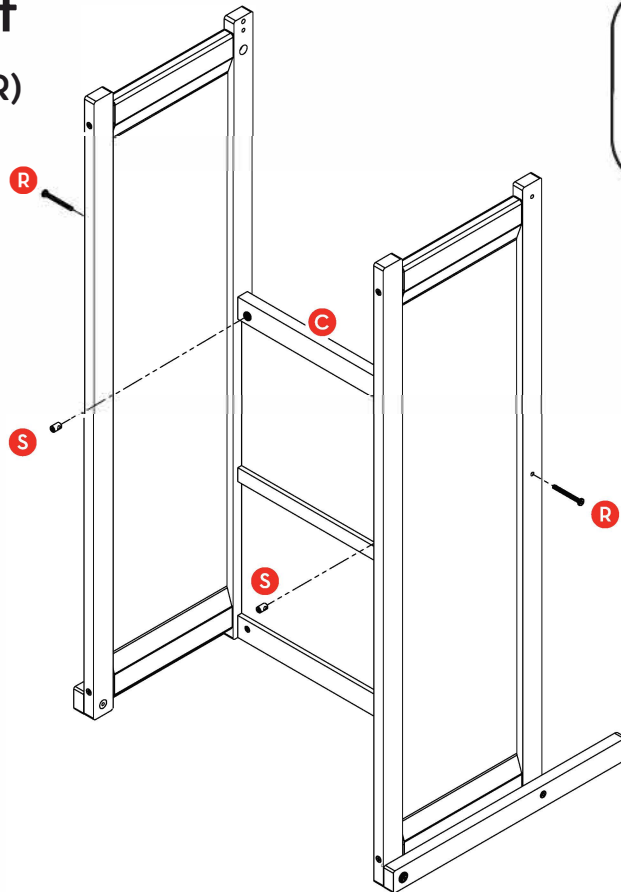

Assembled View

## STEP 6 - Curtain Call

Slide curtains (part G) onto curtain rod (part F) with straps on outside edge.

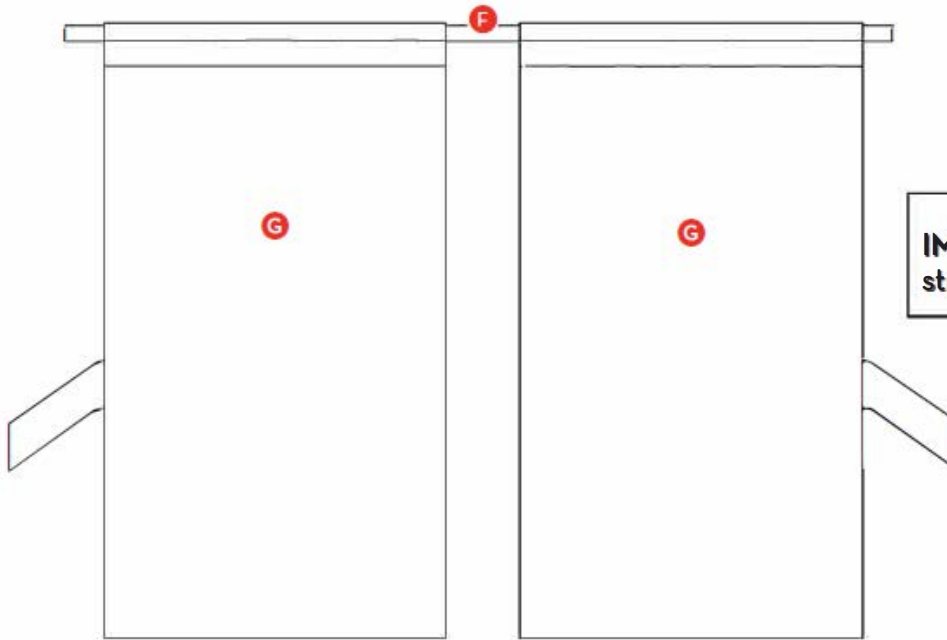

**!**  
**IMPORTANT:** Curtain straps are on the outside.

## STEP 7 - Top Notch

Insert two barrel nuts (part S) into top stretcher (part D—no slot). Using two medium bolts (part R), attach top stretcher to side panels. Leave bolts loose and insert curtain rod with curtains (be sure soft velour side is facing out). After curtain rod is in position, tighten up all the bolts on the puppet theater.

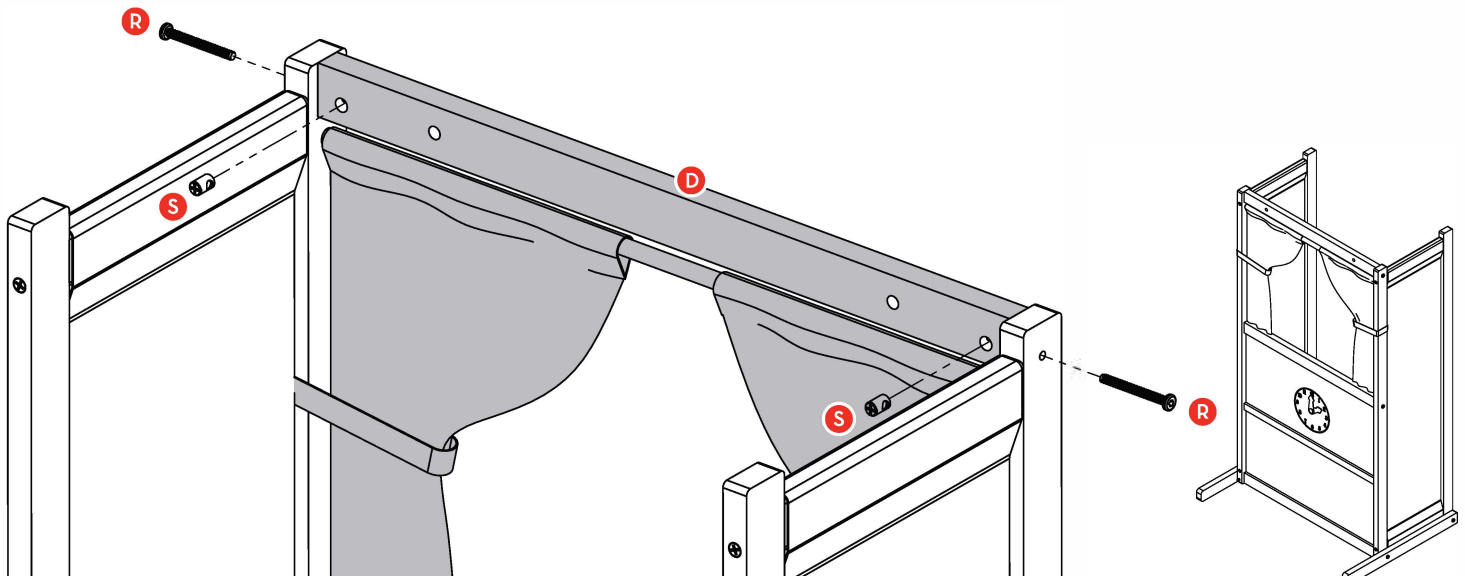
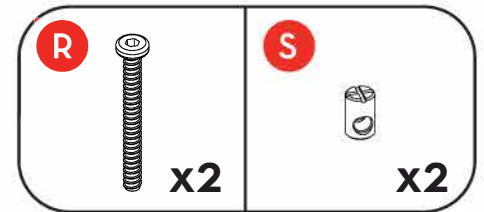

Melissa & Doug Customer Service: 1-800-284-3948

Assembled View

# STEP 8 - Put Up a Good Front

Using two binder nut/bolt sets (part T), attach header panel (part I) to the front of the top stretcher. Be sure artwork is facing out.

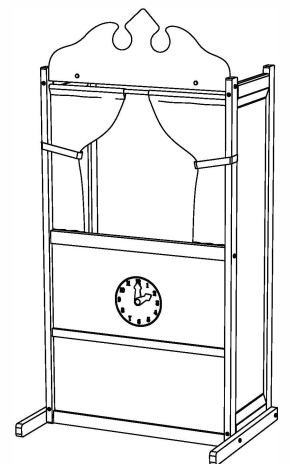
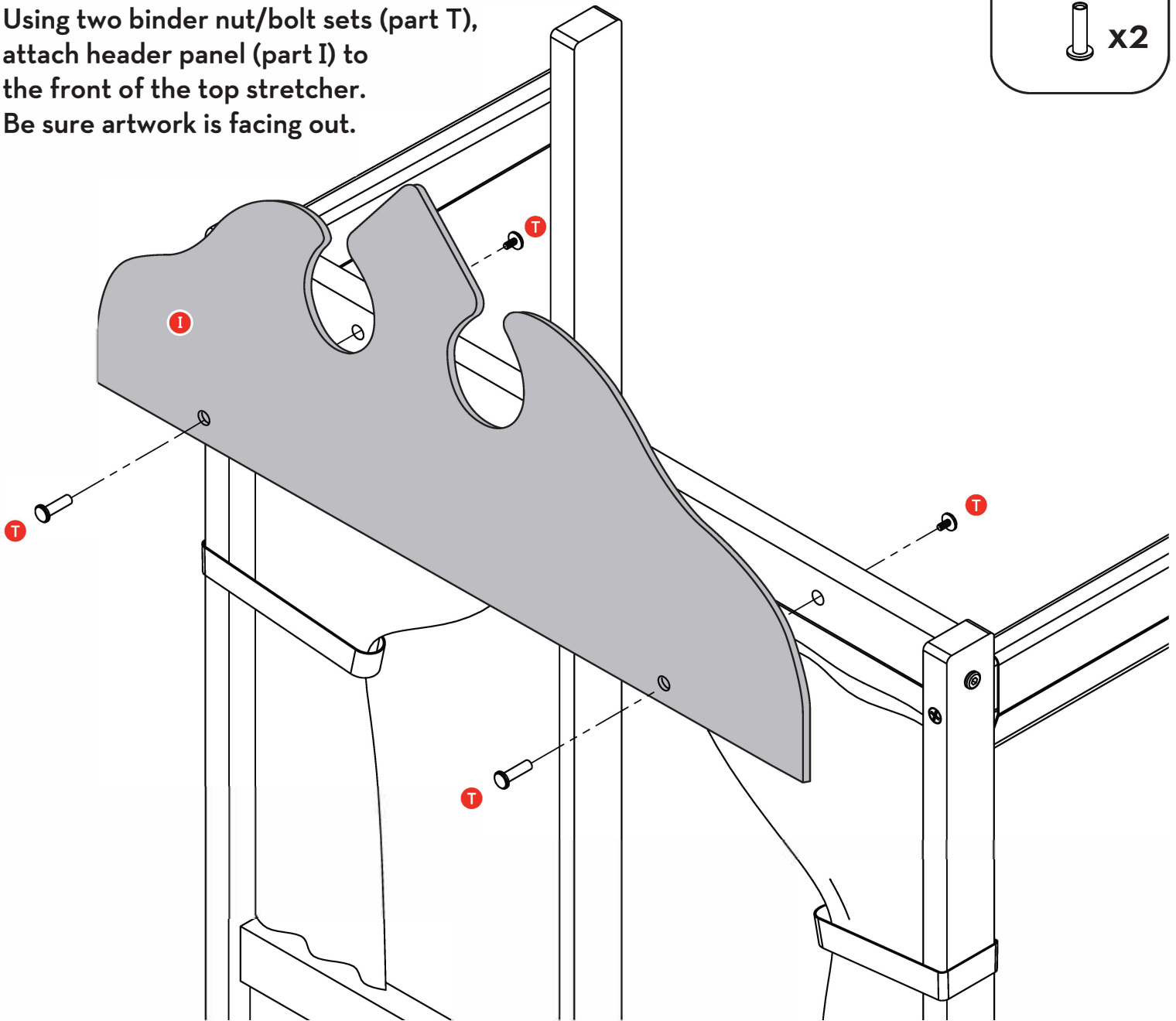
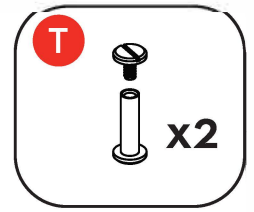

Assembled View

# YOU DID IT!

Now the real fun begins—it's time to raise the curtain on lots of imaginative storytelling! Here are some tips for making the most of your Deluxe Puppet Theater:

- **START WITH A CLEAN SLATE:** The chalkboard on the front of the puppet theater should be “seasoned” before use. Hold a piece of chalk horizontally and rub the entire surface of the chalkboard, covering it completely. With a dry paper towel, use an overlapping circular motion to rub the entire chalkboard surface. Finally, wipe the chalkboard surface with a chalkboard eraser.

Your chalkboard is now seasoned and ready for use!

Make a sign inviting people to your puppet show—“Puppet Show Tonight!” Or, use the chalkboard to write ticket “prices,” the name of the performance, who the stars of the show are, and more!

- **TIME FOR FUN:** Let people know when the show begins by setting the hands of the clock! You can also incorporate the clock into the stories you and your puppets tell—maybe the princess has to leave the ball before midnight, or the puppets at school are waiting for class to dismiss at 3 p.m.
- **CURTAIN COMMENTS:** It's easy to “raise” the curtain to let the show begin! Wrap the tieback loosely around each velour curtain panel and secure with the self stick tab. If you prefer, the tiebacks are long enough to wrap around the side panel rods.

When the show is over, close the curtain by un-doing the tiebacks and sliding the curtains along the curtain rod!

Another way to play is to perform with the curtain closed—hide behind the curtain and hold puppets so they peek through the space in the middle! When the show is over, open the curtains so the puppeteers can take a bow!

---

## ACCESSORIZE

Melissa & Doug offers a wide range of puppets to bring your Deluxe Puppet Theater to life! Offbeat characters and familiar favorites come with detailed clothing and a hand rod. For beginning puppeteers—but sized to fit both kids and adults—our hand puppet sets each offer four adorable themed puppet pals to foster communication and encourage storytelling. For these items and more, visit [MelissaAndDoug.com](http://MelissaAndDoug.com)!